

Instructions for Use

WC flush plate for Prevista Visign for Style 24

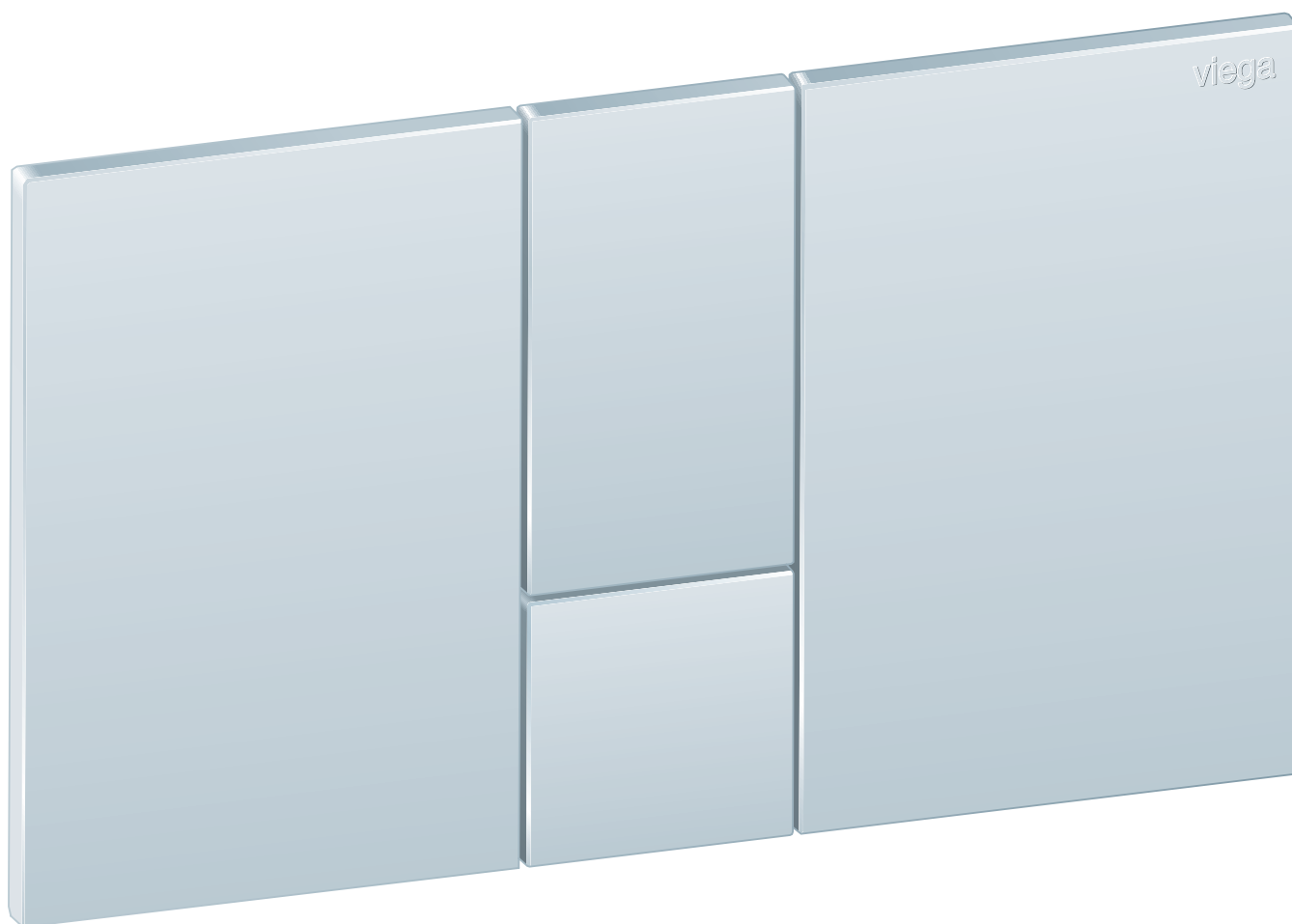

for all Prevista concealed cisterns

Model
8614.1

Year built (from)
03/2019

viega

Table of contents

1	About these instructions for use	3
	1.1 Target groups	3
	1.2 Labelling of notes	3
	1.3 About this translated version	4
2	Product information	5
	2.1 Standards and regulations	5
	2.2 Intended use	5
	2.2.1 Areas of use	5
	2.3 Product description	6
	2.3.1 Overview	6
	2.3.2 Technical data	6
3	Handling	7
	3.1 Assembly	7
	3.1.1 Prepare cistern	7
	3.1.2 Mounting the flush plate	8
	3.2 Commissioning	14
	3.2.1 Setting the flush volume	14
	3.3 Errors, faults and remedy	16
	3.4 Care and maintenance	16
	3.4.1 Care tips	16
	3.5 Disposal	16

1 About these instructions for use

Trade mark rights exist for this document; for further information, go to viega.com/legal.

1.1 Target groups

The information in this instruction manual is directed at the following groups of people:

- Heating and sanitary professionals and trained personnel
- Consumers

Individuals without the abovementioned training or qualification are not permitted to mount, install and, if required, maintain this product. This restriction does not extend to possible operating instructions.

The installation of Viega products must take place in accordance with the general rules of engineering and the Viega instructions for use.

1.2 Labelling of notes

Warning and advisory texts are set aside from the remainder of the text and are labelled with the relevant pictographs.



DANGER!

This symbol warns of possible life-threatening injury.



WARNING!

This symbol warns of possible serious injury.



CAUTION!

This symbol warns of possible injury.



NOTICE!

This symbol warns of possible damage to property.



This symbol gives additional information and hints.

1.3 About this translated version

This instruction for use contains important information about the choice of product or system, assembly and commissioning as well as intended use and, if required, maintenance measures. The information about the products, their properties and application technology are based on the current standards in Europe (e.g. EN) and/or in Germany (e.g. DIN/DVGW).

Some passages in the text may refer to technical codes in Europe/Germany. These should serve as recommendations in the absence of corresponding national regulations. The relevant national laws, standards, regulations, directives and other technical provisions take priority over the German/European directives specified in this manual: The information herein is not binding for other countries and regions; as said above, they should be understood as a recommendation.

2 Product information

2.1 Standards and regulations

The following standards and regulations apply to Germany / Europe and are provided as a support feature.

Regulations from section: Technical data

Scope / Notice	Regulations applicable in Germany
Flush flow	DIN 3265
Noise class	DIN 4109

2.2 Intended use

2.2.1 Areas of use

Suitable cisterns

The flush plate is intended for the actuation of flushes on Viega concealed cisterns.

Installation is possible in all Prevista concealed cisterns.

2.3 Product description

2.3.1 Overview

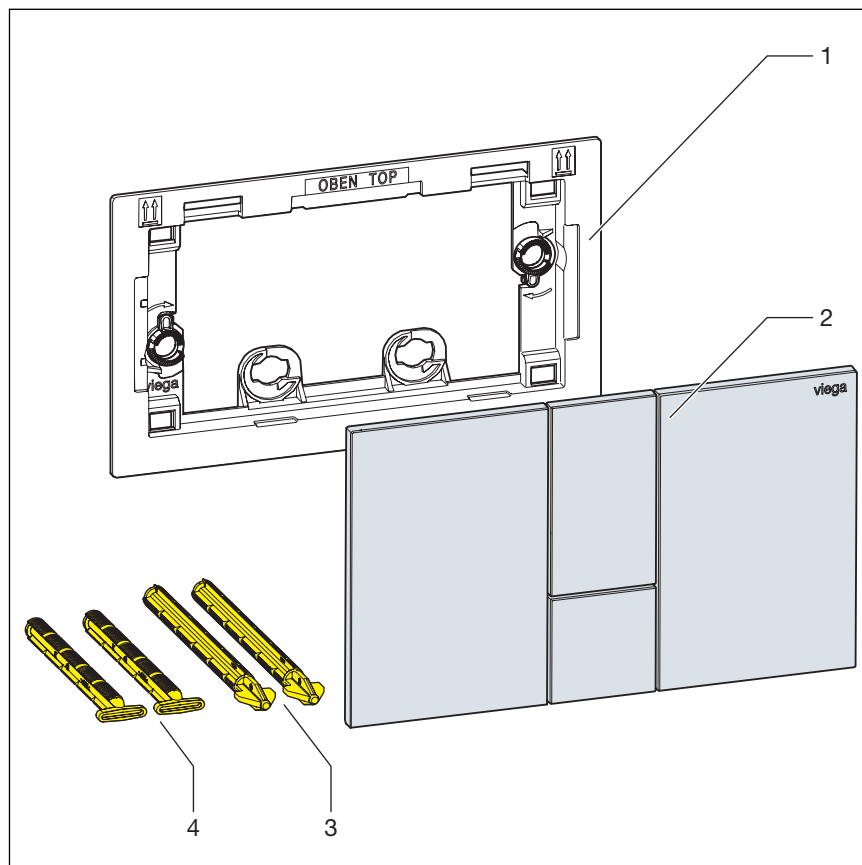

Fig. 1: Scope of delivery

- 1 installation frame
- 2 flush plate
- 3 actuating rods
- 4 retaining bolt

2.3.2 Technical data

Flush volume

The flush volumes for the flush actuation are:

- Small flush volume: approx. 2–4 litres
- Large flush volume: approx. 3.5–7.5 litres

For the setting of the flush see [Chapter 3.2.1 „Setting the flush volume“](#) on page 14.

3 Handling

3.1 Assembly

3.1.1 Prepare cistern

Requirements:

- The cistern is fitted into the pre-wall.
- The pre-wall is tiled.
- Cut into the sticky tape of the shaft cover.

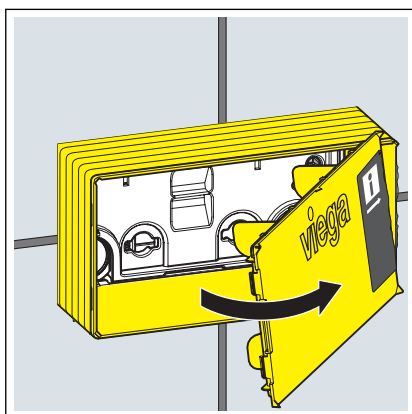
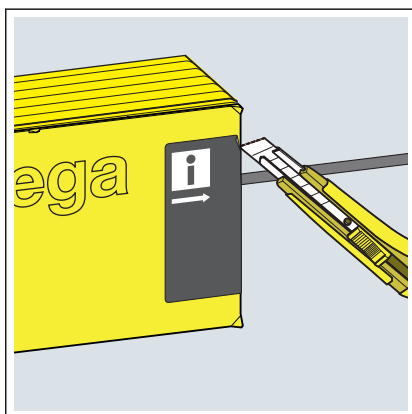

- Remove the shaft cover.

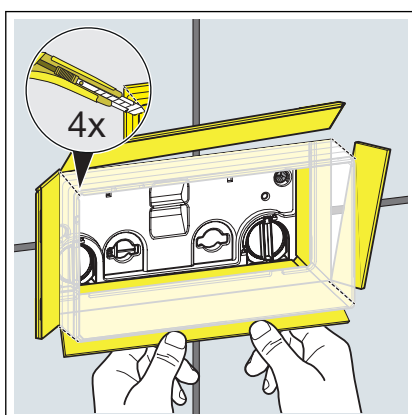

- Cut into the corners of the revision shaft.
- Fold the sides of the revision shaft outwards up to the tile level and snap them off.

3.1.2 Mounting the flush plate

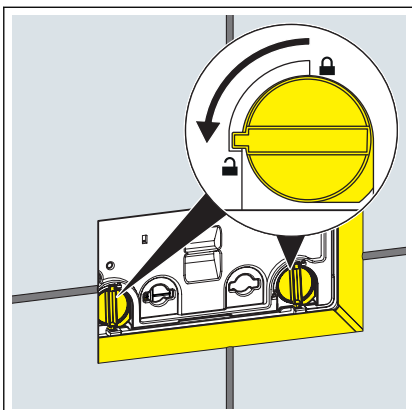

► Turn the cover plate lock 90° in anti-clockwise direction.

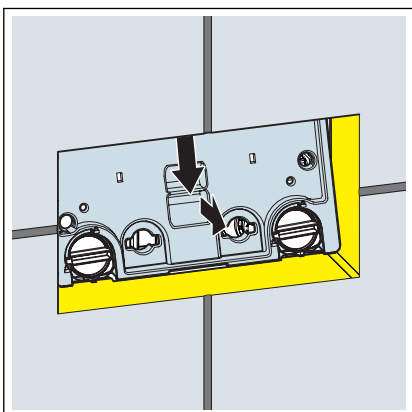

► Remove the cover plate.

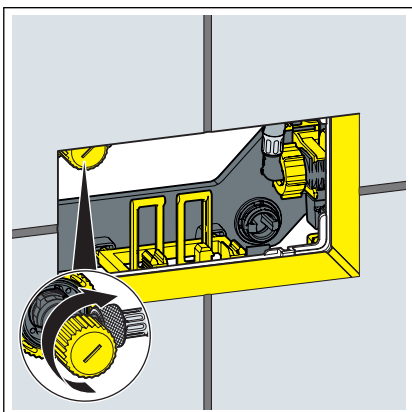

► Close the corner valve.

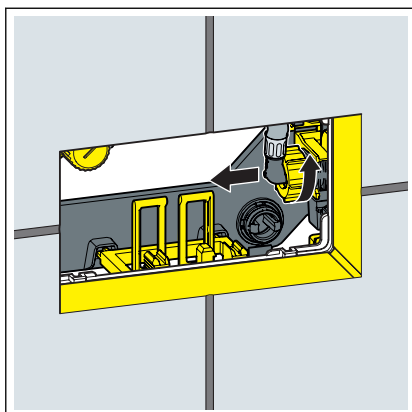

► Loosen the flexible hose at the filling valve.

INFO! For setting the flush volume, see ↗ Chapter 3.2.1 „Setting the flush volume“ on page 14.

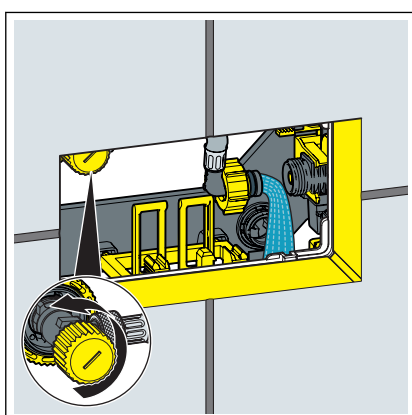

► Open the corner valve for a few seconds to flush the pipe.

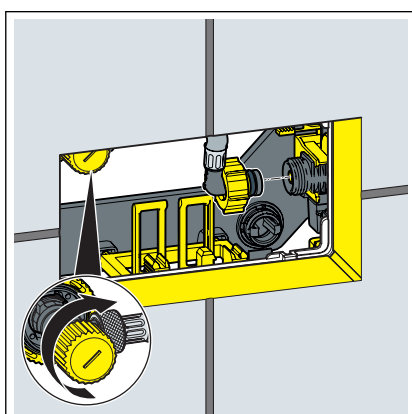

► Close the corner valve.

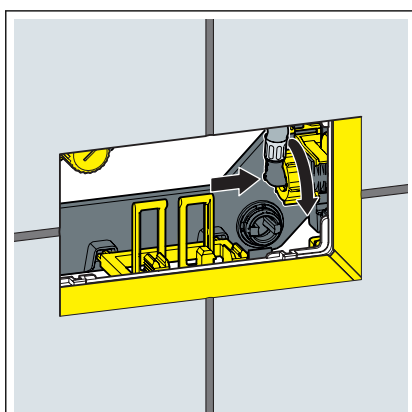

► Connect the flexible hose to the filling valve.

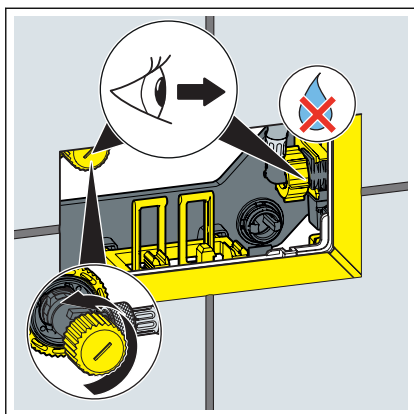

► Re-open the corner valve.

INFO! Check the corner valve and the filling valve for leak tightness.

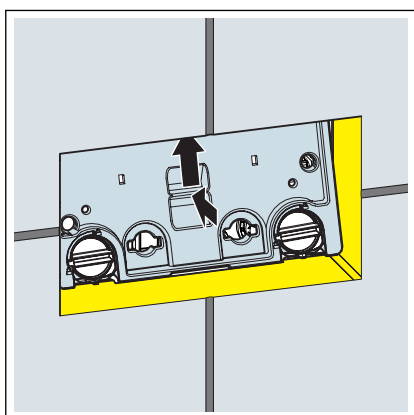

► Insert the cover plate into the cistern.

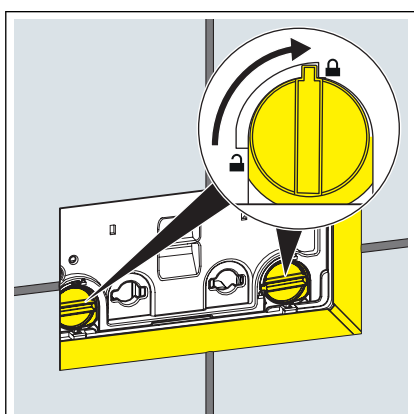

► Turn the cover plate lock by 90° in a clockwise direction.

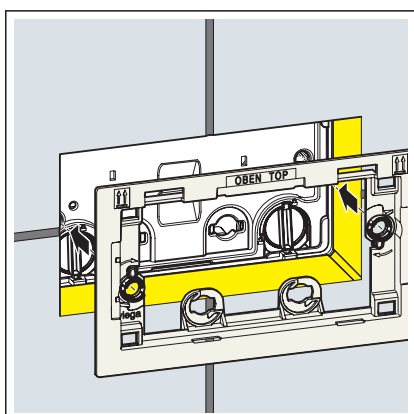

► Put on the installation frame.

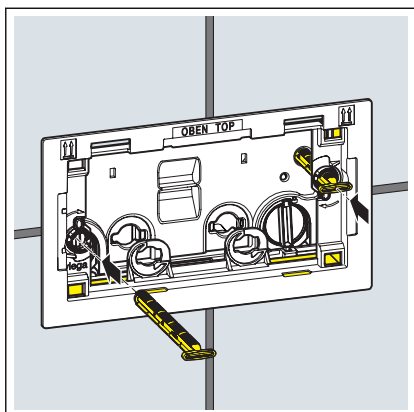

➤ Insert the retaining bolts.

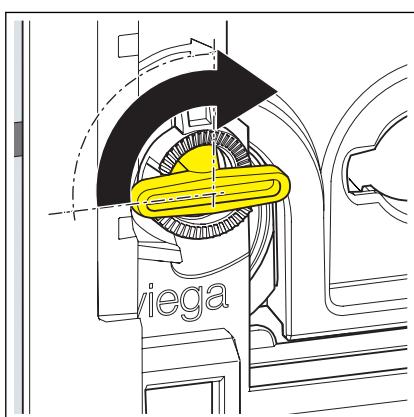

➤ Turn the retaining bolts by 90° in a clockwise direction.

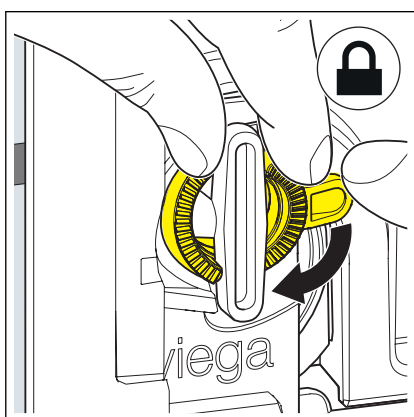

➤ Align the installation frame.

➤ To fix the retaining bolts, turn safety rings in a clockwise direction.

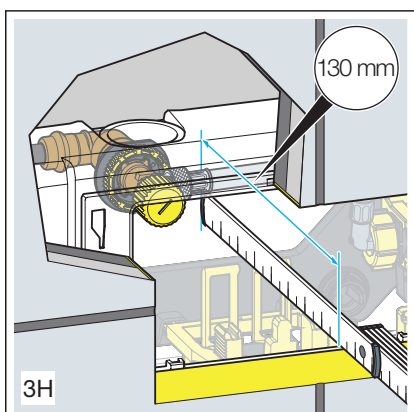

If you are not sure which cistern is installed, identify it by means of the following dimensions.

■ 3H concealed cistern

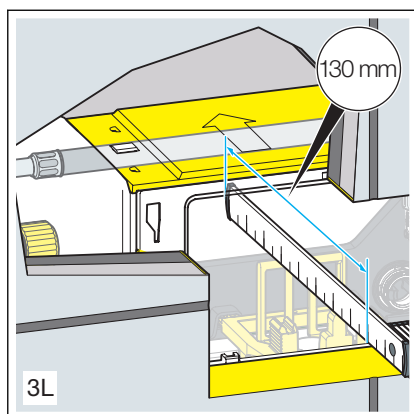

■ concealed cistern 3L

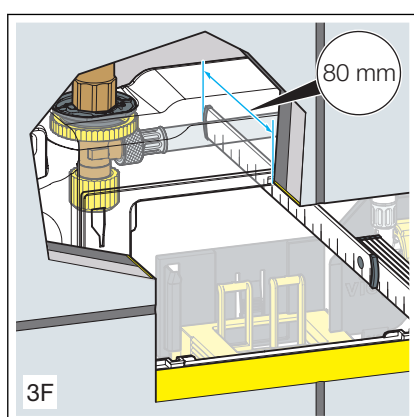

■ Concealed cistern 3F

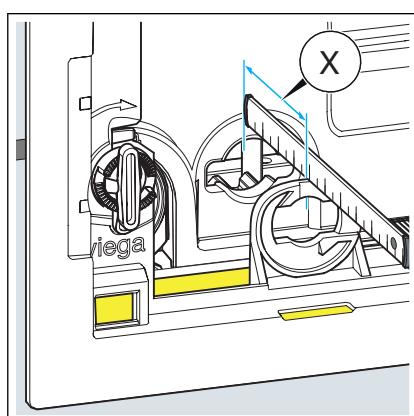

INFO! For installation from the front into the concealed cisterns 3H, 3L, 3S.

► Determine the distance for the actuating rods.

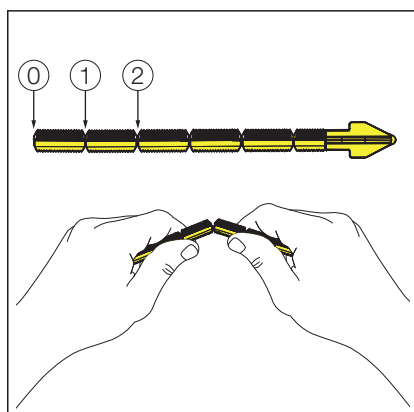

INFO! Cistern 3H and 3L.

► If necessary, cut the actuating rods to length.

- 0: 75–50 mm
- 1: 50–25 mm
- 2: 25–10 mm

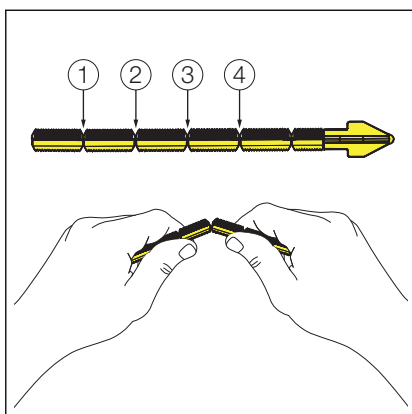

INFO! Cistern 3F.

► If necessary, cut the actuating rods to length.

- 1: 75–55 mm
- 2: 55–35 mm
- 3: 35–15 mm
- 4: 15–10 mm

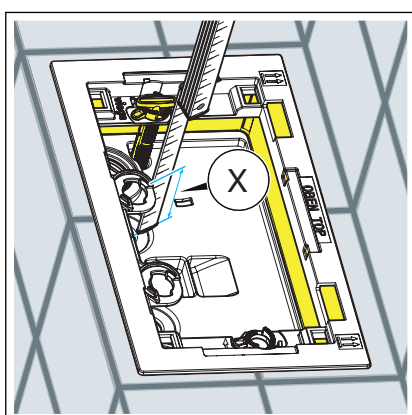

INFO! For installation from above into concealed cistern 3L.

► Determine the distance for the actuating rods.

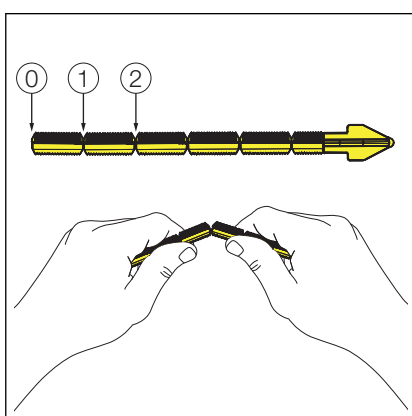

► If necessary, cut the actuating rods to length.

- 0: 60–45 mm
- 1: 45–25 mm
- 2: 25–10 mm

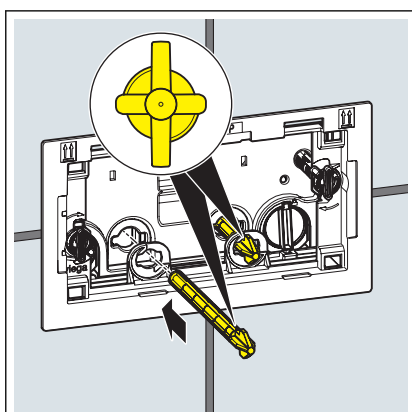

► Insert the actuating rods as far as they will go.

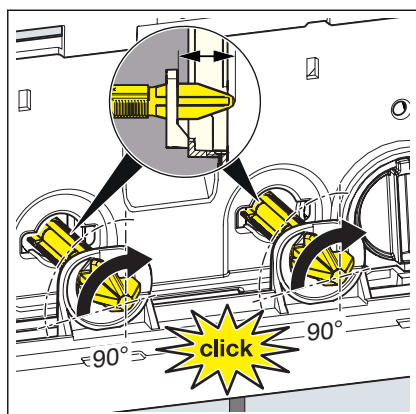

- Align the actuating rods.
- Rotate the actuating rods 90° in clockwise direction.

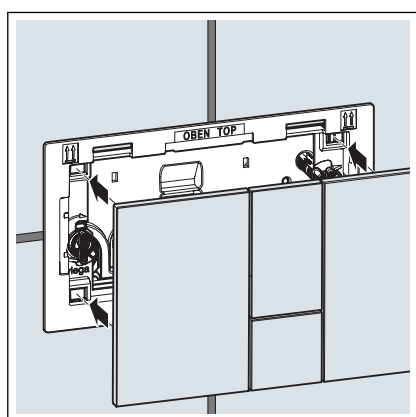

- Mount the flush plate.
- ◻ The flush plate is mounted.

3.2 Commissioning

3.2.1 Setting the flush volume

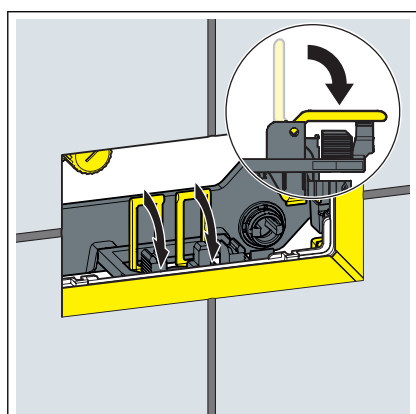

- Fold the tabs forward.

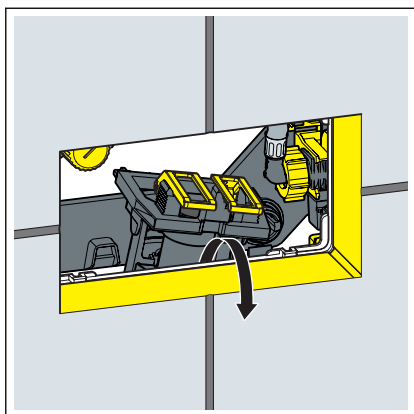

► Lift the drain valve.

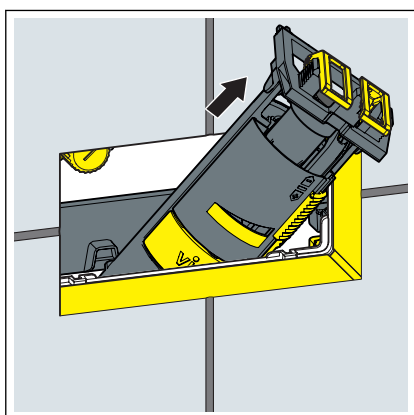

► Remove the drain valve through the revision opening.

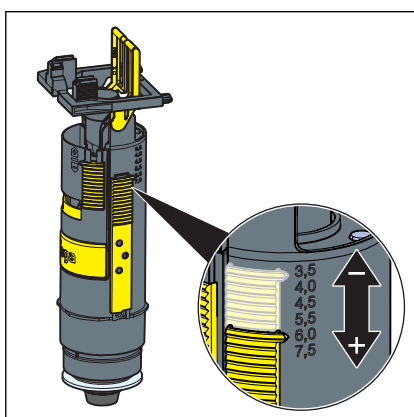

► Set the large flush volume at the drain valve.

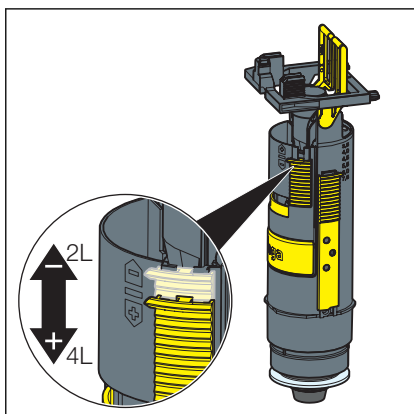

► Set the small flush volume at the drain valve.

3.3 Errors, faults and remedy

Error	Cause	Remedy
The WC does not flush.	The cistern is not yet completely full.	Wait until the cistern is sufficiently full.
	There is no water in the cistern. The corner valve is closed.	Open the corner valve.
The WC flush runs through.	The seal at the filling valve is dirty or damaged.	Check the seal, replace if necessary.
	The seal at the drain valve is dirty or damaged.	Check the seal, replace if necessary.

3.4 Care and maintenance

3.4.1 Care tips

Use normal soap or a mild cleaning agent for regular care and prevention of lime scale on the flush plate. Under no circumstances should scouring agent or scratching objects be used.

Strong stains can be removed using typical household cleaner. Rinse the detergent thoroughly with clear water after the prescribed exposure time. There should be no residue on the components.

3.5 Disposal

Separate the product and packaging materials (e. g. paper, metal, plastic or non-ferrous metals) and dispose of in accordance with valid national legal requirements.



Viega Technology GmbH & Co. KG

service-technik@viega.de

viega.com

INT • 2020-07 • VPN200186

